

EXCO A Standard Profile Aluminium Entrance Matting with Needle-punch Carpet

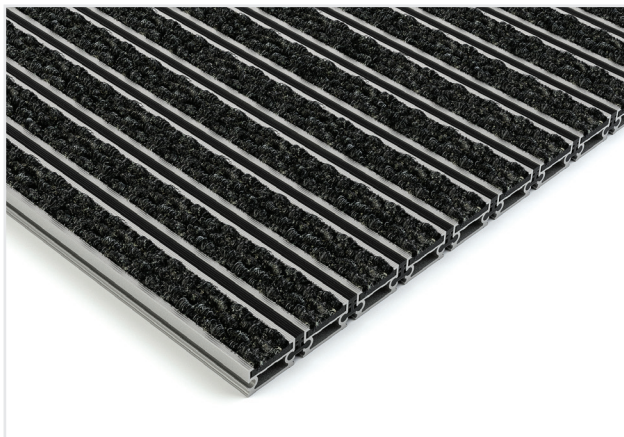

PRODUCT DATASHEET

excelmatting.co.uk



FEATURES AND BENEFITS



ICON KEY ON SECOND PAGE

- ➔ Robust, high-quality aluminium system for heavy-duty use designed to cope with high footfall.
- ➔ Flexible, yet durable PVC linking joints for ease of handling and easy fitting.
- ➔ Custom-made to order to your specification.
- ➔ Accessories available.
- ➔ Manufactured in the UK.

Technical Specification

Uniclass	Pr_35_57_11_26 Entrance mats
CAWS	N10 / 300 Entrance Matting
Material	Aluminium rails, PVC connection strips, Carpet Inlays
Surface Finish	Carpet
Product Height	17 mm
Durability	Heavy to very heavy traffic entrances
Environmental Resistance	Suitable for dry environments
UV Resistance	Yes
Typical Applications	Entrance areas
Installation Method	Installed into recessed well
Other Product Performance Information	Uniform floor load = 14.36 KN/ m ² . Wheel load 159 kg per wheel
Fire Tested to	BS EN 13501-1 Class E _n – s2
Slip Tested to	BS 7976-2 – low slip potential
COO (Country of Origin)	UK

Notes: Slip resistance specifications are based on the correct direction of travel i.e. perpendicular to the rails and inserts. **Black Anodised finish availability is subject to quantity required.**

STYLES AND COLOURS



Standard Profile Aluminium
Open Surface
Grey Needlepunch



Standard Profile Black Anodised
Open Surface
Charcoal Needlepunch



Standard Profile Aluminium
Closed Surface
Grey Needlepunch

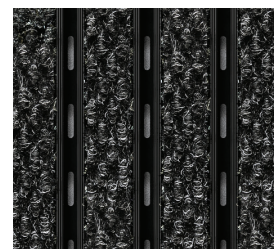

Standard Profile Black Anodised
Closed Surface
Charcoal Needlepunch



Standard Profile Aluminium
Closed Surface
Grey Needlepunch

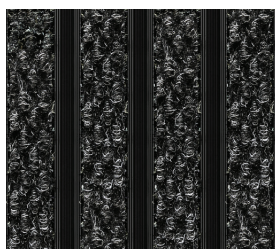

Standard Profile Black Anodised
Closed Surface
Charcoal Needlepunch

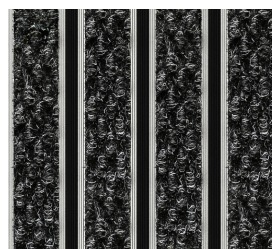

Standard Profile Aluminium
Closed Surface
Grey Needlepunch

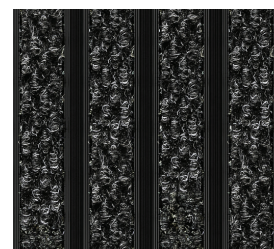

Standard Profile Black Anodised
Closed Surface
Charcoal Needlepunch

EXCO A Standard Profile Aluminium Entrance Matting with Needle Punch Carpet

PRODUCT DATASHEET

excelmatting.co.uk



ZONES

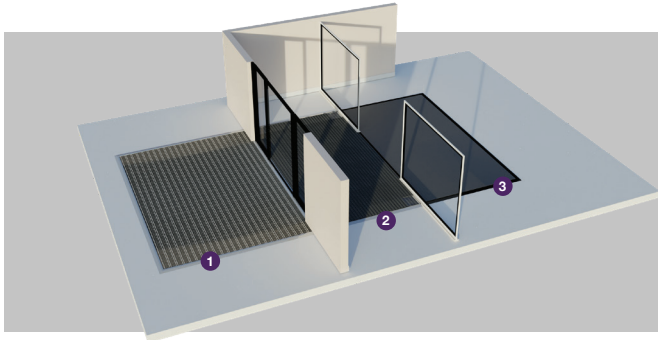

Zones

We recommend a zoning system when choosing your entrance matting. Whether your entrance extends outdoors or is fully covered, creating three zones delivers optimum dirt barrier performance, ensuring interior floors are kept clean and hazard free.



Light	Medium	High	Very High	Light	Medium	Heavy Duty	Max Duty	Dirt	Moisture
Less than 80 people per hour 3-4 metres	Up to 300 people per hour 6-7 metres	Around 600 people per hour 8-10 metres	Over 5,000 people per day 9-12 metres	Suitcases, Wheelchairs	Supermarket Trolleys, Sack barrows, Luggage trolleys	Supermarket Cages, Pallet Trucks	Forklift Trucks, Hydraulic Cranes	Most Effective Against Dirt/Soil	Most Effective Against Moisture
Pedestrian Traffic				Wheeled Traffic			Contaminants		
It is important that matting is a sufficient length to allow moisture and debris to be wiped off footwear as people walk across the mat. Our team recommends a minimum of six footsteps for this to be effective.				Depending on the nature of the building, the entrance may have to contend with different types of wheeled traffic. It is important that all matting complies with DDA Regulations/The Equality Act, so that wheelchairs can safely move on and off.			All of our products protect you against contaminants, but some products are more effective than others for removing either dirt or moisture. Use these icons to determine which.		

INSTALLATION

EXCO A Aluminium Closed Surface Standard Profile Entrance Matting Installed in a recessed well

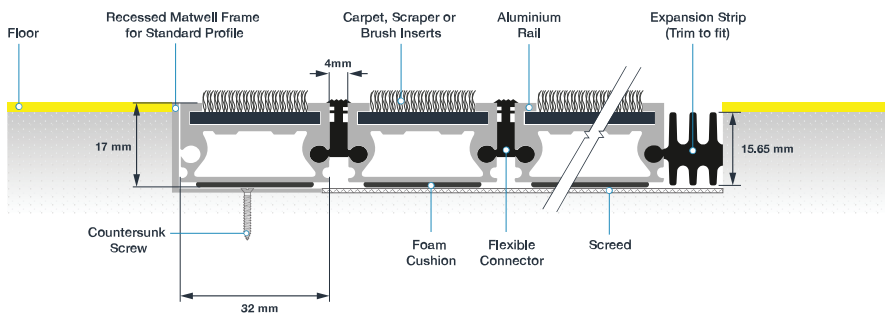

Note: The Closed Surface and Open Surface options are dependent on preference and both can be installed in a matwell

EXCO A Aluminium Open Surface Standard Profile Entrance Matting Installed in a recessed well

